



Urban
*Act*TM *β*
Floodlight





Urban Act β is a lightweight and compact floodlight with integral electronic ballast. The Urban Act β is designed for demanding indoor and outdoor lighting concepts and designed to simplify installation. Urban Act β fits any indoor and outdoor floodlighting applications.



Lightweight and compact

Lightweight and compact size make installation easier and safer.



Various accessories

Various accessories are available; arms, flanges, fittings, filters, guards, louvers etc.



Tool-free lamp replacement & adjustment

Easy lamp replacement by hand.
Tool-free adjustment by special turn lock mechanism.



EYE Cera Arc

High efficacy, high colour rendering, long life Ceramic Metal Halide

EYE Color Arc

Ra 96; highest colour rendering compact Metal Halide

EYE Color Arc Color

Blue, Green, Magenta

Flexible and universal operating position

Allows for installation in many different ways including arm mounting and surface mounting.

Useful for illuminating advertising panels, landscapes, architectural details, shop windows and streets etc.

Protection

IP65

Full E.C.G. circuit & lamp protection.

Thermally protected.

Transient protected.

Energy saving

The integral electronic ballast saves energy approx. 9% compared to conventional core & coil ballast.

Superior quality of light output

Electronic ballast operation regulates lamp voltage and minimises lamp to lamp colour variation.

Wide variety of lamp types

Urban Act β is designed for high efficacy high colour rendering compact ceramic metal halide EYE Cera Arc and the highest colour rendering metal halide EYE Color Arc lamps. Wide selection of colour temperatures, colour rendering types and colours are available.

Ideal colour temperatures for applications can be selected from various colour temperature types in each lamp family.

Urban Act™ β Mini



Urban Act β Mini for metal halide lamps
Axially symmetrical narrow, medium wide beam
Asymmetrical wide beam

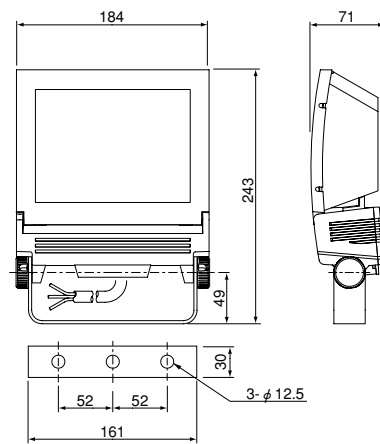

Weight: 2.0kg
Protection: IP65
Housing: aluminium die cast
Reflector: aluminium faceted / dimpled
Front glass: tempered glass
With fluoropolymer dust proof filter
Integral electronic ballast
Easy lamp replacement
Tool-free adjustment by special turn lock mechanism
Complete with 1200 mm supply cable 3 x 1.0mm²



Lamp

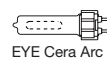

EYE Cera Arc

Urban Act β Mini for 35W metal halide, axially symmetrical narrow beam

Model	Colour	Lamp	Lamp holder	C0-180	C90-270
HCF0375BHE/DG	Dark Gray	EYE Cera Arc Tubular 35W	G12	9°	11°
HCF0375BHE/W	White	EYE Cera Arc Tubular 35W	G12	9°	11°

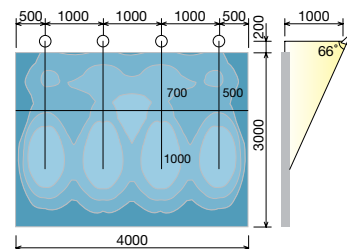
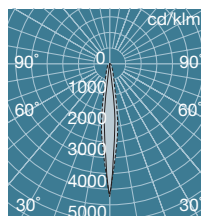

HCF0775BHE + CMT70/WW/G12
6000 lm

Urban Act β Mini for 70W metal halide, axially symmetrical narrow beam

Model	Colour	Lamp	Lamp holder	C0-180	C90-270
HCF0775BHE/DG	Dark Gray	EYE Cera Arc Tubular 70W	G12	9°	11°
HCF0775BHE/W	White	EYE Cera Arc Tubular 70W	G12	9°	11°

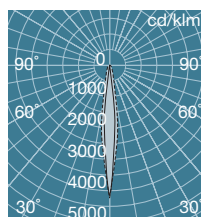

Urban Act β Mini for 35W metal halide, axially symmetrical medium wide beam

Model	Colour	Lamp	Lamp holder	C0-180	C90-270
HCF0374BHE/DG	Dark Gray	EYE Cera Arc Tubular 35W	G12	17°	20°
HCF0374BHE/W	White	EYE Cera Arc Tubular 35W	G12	17°	20°

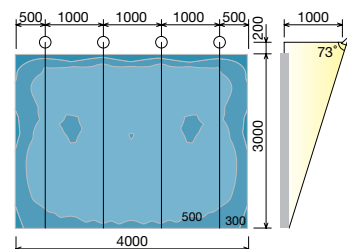
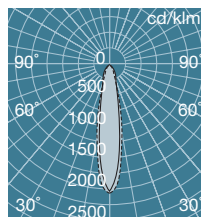

HCF0774BHE + CMT70/WW/G12
6000 lm

Urban Act β Mini for 70W metal halide, axially symmetrical medium wide beam

Model	Colour	Lamp	Lamp holder	C0-180	C90-270
HCF0774BHE/DG	Dark Gray	EYE Cera Arc Tubular 70W	G12	17°	20°
HCF0774BHE/W	White	EYE Cera Arc Tubular 70W	G12	17°	20°

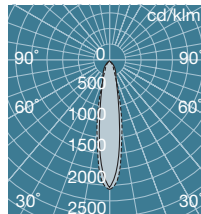

Urban Act β Mini for 35W metal halide, asymmetrical wide beam

Model	Colour	Lamp	Lamp holder	C0-180	C90-270
HCF0373BHE/DG	Dark Gray	EYE Cera Arc Tubular 35W	G12	46°	60°
HCF03735BHE/W	White	EYE Cera Arc Tubular 35W	G12	46°	60°

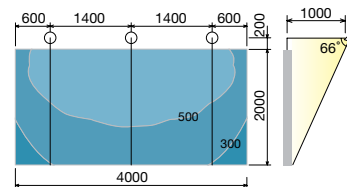
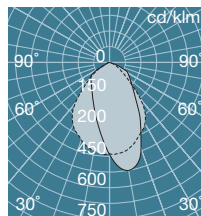

HCF0773BHE + CMT70/WW/G12
6000 lm

Urban Act β Mini for 70W metal halide, asymmetrical wide beam

Model	Colour	Lamp	Lamp holder	C0-180	C90-270
HCF0773BHE/DG	Dark Gray	EYE Cera Arc Tubular 70W	G12	46°	60°
HCF0773BHE/W	White	EYE Cera Arc Tubular 70W	G12	46°	60°

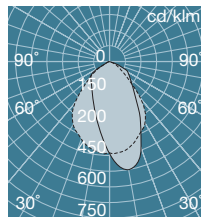

Urban Act™ β -Square



Urban Act β Square for metal halide lamps
Asymmetrical medium wide beam
Axially symmetrical wide beam

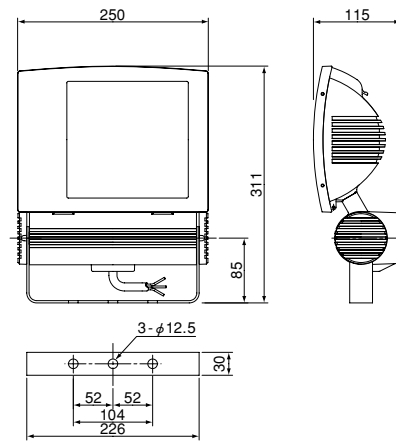

Weight: 3.5kg
Protection: IP65
Housing: aluminium die cast
Reflector: aluminium faceted / dimpled
Front glass: tempered glass
With fluoropolymer dust proof filter
Integral electronic ballast
Easy lamp replacement
Tool-free adjustment by special turn lock mechanism
Complete with 1200 mm supply cable 3 x 1.0mm²



Lamp

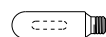

EYE Cera Arc Frosted
EYE Color Arc Frosted

Urban Act β Square for 70W metal halide, asymmetrical medium wide beam

Type	Colour	Lamp	Lamp holder	C0-180	C90-270
HCF0772BHE	Dark Gray	EYE Cera Arc Tubular 70W Frosted EYE Color Arc Tubular 70W Frosted	E27	17°	25°
HCF0772BHE/W	White	EYE Cera Arc Tubular 70W Frosted EYE Color Arc Tubular 70W Frosted	E27	17°	25°

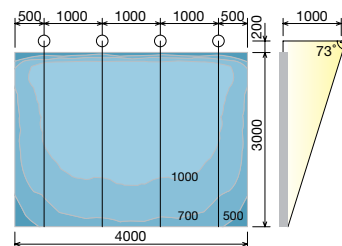
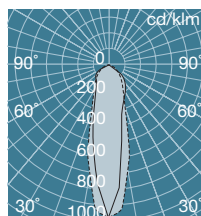

HCF1572BHE + CMT150F/WW
13000 lm

Urban Act β Square for 150W metal halide, asymmetrical medium wide beam

Type	Colour	Lamp	Lamp holder	C0-180	C90-270
HCF1572BHE	Dark Gray	EYE Cera Arc Tubular 150W Frosted EYE Color Arc Tubular 150W Frosted	E27	17°	25°
HCF1572BHE/W	White	EYE Cera Arc Tubular 150W Frosted EYE Color Arc Tubular 150W Frosted	E27	17°	25°

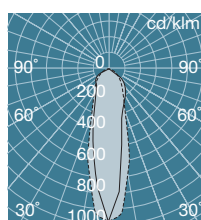

Urban Act β Square for 70W metal halide, axially symmetrical wide beam

Type	Colour	Lamp	Lamp holder	C0-180	C90-270
HCF0771BHE	Dark Gray	EYE Cera Arc Tubular 70W Frosted EYE Color Arc Tubular 70W Frosted	E27	48°	64°
HCF0771BHE/W	White	EYE Cera Arc Tubular 70W Frosted EYE Color Arc Tubular 70W Frosted	E27	48°	64°

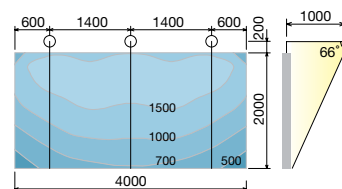
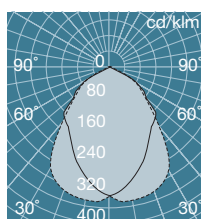

HCF1571BHE + CMT150F/WW
13000 lm

Urban Act β Square for 150W metal halide, axially symmetrical wide beam

Type	Colour	Lamp	Lamp holder	C0-180	C90-270
HCF1571BHE	Dark Gray	EYE Cera Arc Tubular 150W Frosted EYE Color Arc Tubular 150W Frosted	E27	48°	64°
HCF1571BHE/W	White	EYE Cera Arc Tubular 150W Frosted EYE Color Arc Tubular 150W Frosted	E27	48°	64°

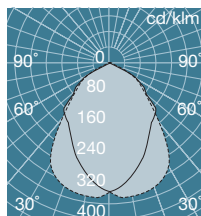

Urban Act™ β -Round



Urban Act β Round for metal halide lamps
Symmetrical super narrow,
Narrow and medium wide beam

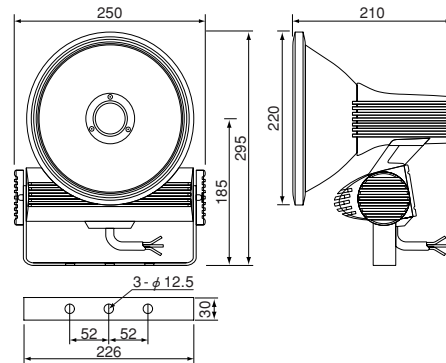

Weight: 3.0kg
Protection: IP65
Housing: aluminium die cast
Reflector: aluminium smooth / faceted / dimpled
Front glass: tempered glass
With fluoropolymer dust proof filter
Integral electronic ballast
Easy lamp replacement
Tool-free adjustment by special turn lock mechanism
Complete with 1200 mm supply cable 3 x 1.0mm²



Lamp

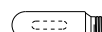

EYE Cera Arc
EYE Color Arc

Urban Act β Round for 70W metal halide, symmetrical super narrow beam

Model	Colour	Lamp	Lamp holder	Beam angle
HCF0721BHE	Dark Gray	EYE Cera Arc Tubular 70W EYE Color Arc Tubular 70W	E27	6°
HCF0721BHE/W	White	EYE Cera Arc Tubular 70W EYE Color Arc Tubular 70W	E27	6°

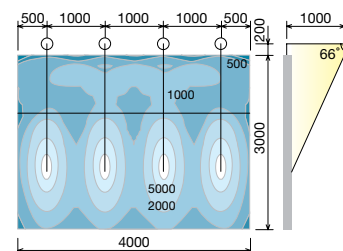
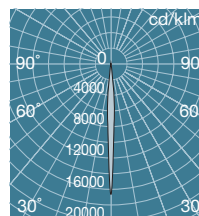
HCF0721BHE + CMT150/WW
13500 lm

Urban Act β Round for 150W metal halide, symmetrical super narrow beam

Model	Colour	Lamp	Lamp holder	Beam angle
HCF1521BHE	Dark Gray	EYE Cera Arc Tubular 150W EYE Color Arc Tubular 150W	E27	6°
HCF1521BHE/W	White	EYE Cera Arc Tubular 150W EYE Color Arc Tubular 150W	E27	6°

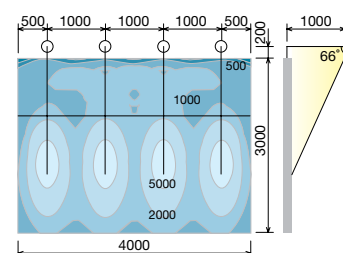
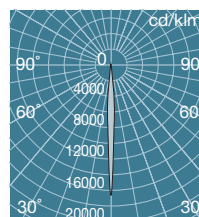
HCF1521BHE + CMT150/WW
13500 lm

Urban Act β Round for 70W metal halide, symmetrical narrow beam

Model	Colour	Lamp	Lamp holder	Beam angle
HCF0722BHE	Dark Gray	EYE Cera Arc Tubular 70W EYE Color Arc Tubular 70W	E27	9°
HCF0722BHE/W	White	EYE Cera Arc Tubular 70W EYE Color Arc Tubular 70W	E27	9°

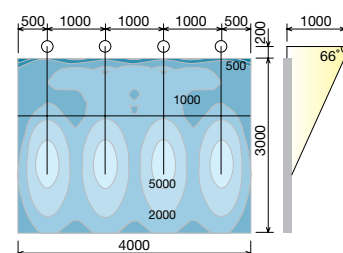
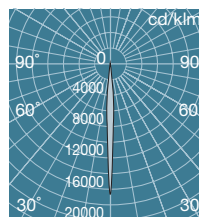
HCF0722BHE + CMT150/WW
13500 lm

Urban Act β Round for 150W metal halide, symmetrical narrow beam

Model	Colour	Lamp	Lamp holder	Beam angle
HCF1522BHE	Dark Gray	EYE Cera Arc Tubular 150W EYE Color Arc Tubular 150W	E27	9°
HCF1522BHE/W	White	EYE Cera Arc Tubular 150W EYE Color Arc Tubular 150W	E27	9°

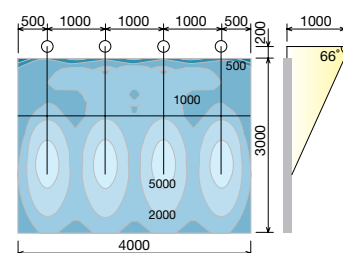
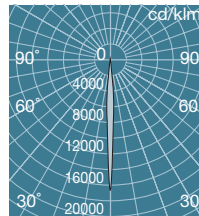
HCF1522BHE + CMT150/WW
13500 lm

Urban Act β Round for 70W metal halide, symmetrical medium wide beam

Model	Colour	Lamp	Lamp holder	Beam angle
HCF0723BHE	Dark Gray	EYE Cera Arc Tubular 70W EYE Color Arc Tubular 70W	E27	23°
HCF0723BHE/W	White	EYE Cera Arc Tubular 70W EYE Color Arc Tubular 70W	E27	23°

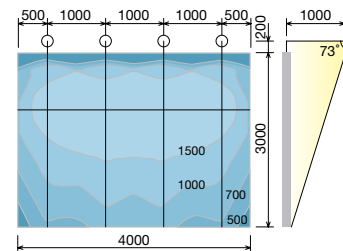
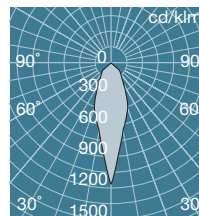
HCF0723BHE + CMT150/WW
13500 lm

Urban Act β Round for 150W metal halide, symmetrical medium wide beam

Model	Colour	Lamp	Lamp holder	Beam angle
HCF1523BHE	Dark Gray	EYE Cera Arc Tubular 150W EYE Color Arc Tubular 150W	E27	23°
HCF1523BHE/W	White	EYE Cera Arc Tubular 150W EYE Color Arc Tubular 150W	E27	23°

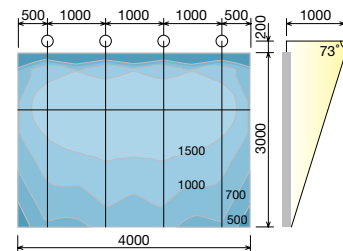
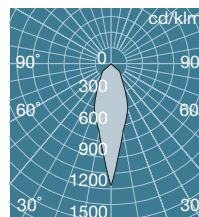

HCF1523BHE + CMT150/WW
13500 lm

Accessories

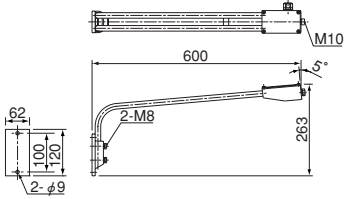
FA-2

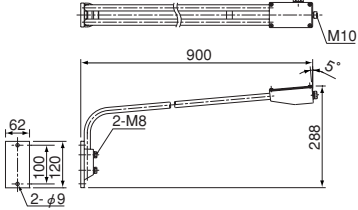

FA-3



FA-1

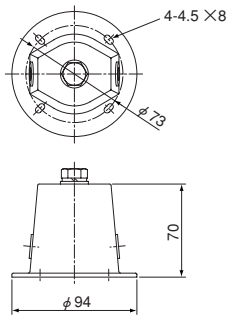

FA-20

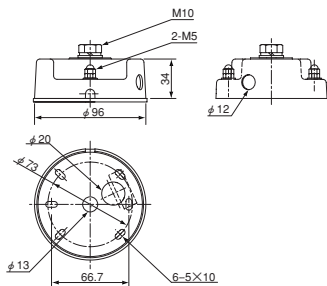

FA-17

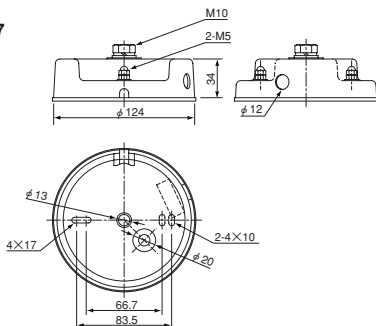

Model	Colour	Description
FA-2	Dark Gray	Wall Arm 600 mm Arm: stainless steel, Junction box: aluminium die cast Weight: 2.0 kg
FA-2/W	White	
FA-3	Dark Gray	Wall Arm 900 mm Arm: stainless steel, Junction box: aluminium die cast Weight: 2.3 kg
FA-3/W	White	



Model	Colour	Description
FA-1	Dark Gray	Flange aluminium die cast Weight: 0.15 kg
FA-1/W	White	



Model	Colour	Description
FA-20/DG	Dark Gray	Flange for wall and ground for Urban Act β Mini aluminium die cast Weight: 0.25 kg
FA-20/W	White	
FA-17	Dark Gray	Flange for wall and ground aluminium die cast Weight: 0.35 kg
FA-17/W	White	

FA-30

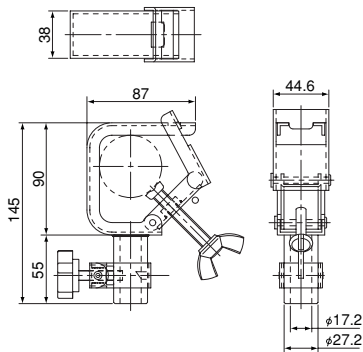

Model	Colour	Description
FA-30/BK	Black	Mounting bracket for trade show trusses; 30-45mm round or 45mm square pipes** steel Weight: 0.6 kg
FA-30/SL	Silver	
FA-31/BK	Black	Bolt for FA30 mounting bracket
FA-31/SL	Silver	
FA-32	Silver	Safety wire for truss mounting

** Do not use Urban Act β as portable luminaires.

GHCF773

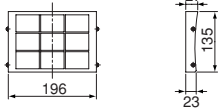

GHCF571

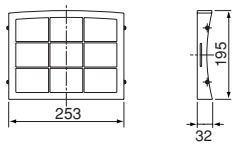

Model	Colour	Description
GHCF773	Black	Protection grill for Urban Act β Mini stainless steel Weight 0.18 kg
GHCF571	Black	Protection grill for Urban Act β Square stainless steel Weight 0.25 kg
GHCF501	Black	Protection grill for Urban Act β Round Guard: stainless steel, Adapter ring: heat resistant resin Weight 0.26 kg

GHCF501



FHCF773

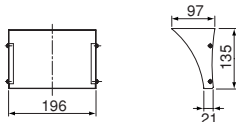

FHCF571

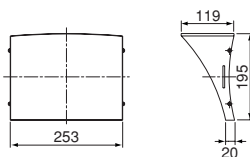

FHCF501

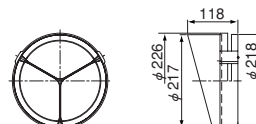

Model	Colour	Description
FHCF773	Black	Visor for Urban Act β Mini stainless steel Weight 0.25 kg
FHCF571	Black	Visor for Urban Act β Square stainless steel Weight 0.35 kg
FHCF501	Black	Visor for Urban Act β Round Visor: stainless steel, Adapter ring: heat resistant resin Weight 0.67 kg



Iwasaki Electric Co., Ltd.
12-4, Shiba 3-chome, Minato-ku, Tokyo 105-0014, Japan
Tel: +81-3-3454-1841 Fax: +81-3-3454-1974
E-mail: iwasaki-ibd@eye.co.jp
www.eye.co.jp

Overseas sales offices

Australia:

EYE Lighting Australia Pty Ltd.
151 Wellington Road
East Brisbane QLD 4169, Australia
Tel: +61-7-3391-8622
Fax: +61-7-3393-0394
www.eyelighting.com.au

Hong Kong:

EYE Lighting (Hong Kong) Ltd.
Room 609, Silvercord Tower 2
30 Canton Road, Tst, Kowloon
Hong Kong
Tel: +852-2368-8782
Fax: +852-2481-2661
E-mail: contact@eyelighting.com.hk
www.eyelighting.com.hk

New Zealand:

EYE Lighting New Zealand Ltd.
6 Tiri place, Mt. Wellington
Auckland, New Zealand
Tel: +64-9-276-8099
Fax: +64-9-276-3474
www.eyelighting.co.nz

Singapore:

EYE Lighting Asia Pacific Pte Ltd.
21, Kaki Bukit Place, Eunos Techpark
Singapore 416199
Tel: +65-6742-3611
Fax: +65-6743-5202
E-mail: support@eyelighting.com.sg

UK:

Iwasaki EYE Lighting Europe (UK)
Unit 2, Eskdale Road, Uxbridge
Middlesex UB8 2RT, UK
Tel: +44-1895-814418
Fax: +44-1895-814666
E-mail: sales@iwasaki.co.uk
www.iwasaki.co.uk

USA:

EYE Lighting International
of North America, Inc.
9150 Hendricks Rd.
Mentor, OH 44060-2146, USA
Tel: +1-440-350-7000
Fax: +1-440-350-7001
E-mail: sales@eyelighting.com
www.eyelighting.com