

Urban Act™ β -Round

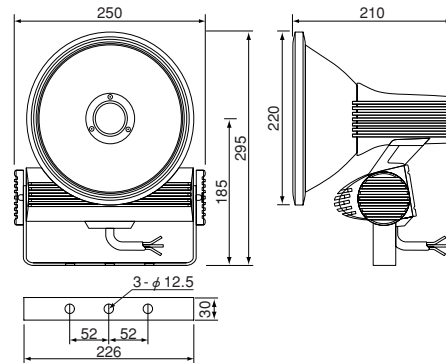

Urban Act β Round for metal halide lamps
Symmetrical super narrow,
Narrow and medium wide beam



Weight: 3.0kg
Protection: IP65
Housing: aluminium die cast
Reflector: aluminium smooth / faceted / dimpled
Front glass: tempered glass
With fluoropolymer dust proof filter
Integral electronic ballast
Easy lamp replacement
Tool-free adjustment by special turn lock mechanism
Complete with 1200 mm supply cable 3 x 1.0mm²



Lamp

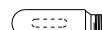

EYE Cera Arc
EYE Color Arc

Urban Act β Round for 70W metal halide, symmetrical super narrow beam

Model	Colour	Lamp	Lamp holder	Beam angle
HCF0721BHE	Dark Gray	EYE Cera Arc Tubular 70W EYE Color Arc Tubular 70W	E27	6°
HCF0721BHE/W	White	EYE Cera Arc Tubular 70W EYE Color Arc Tubular 70W	E27	6°

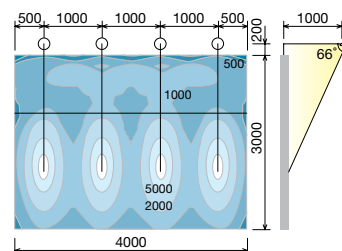
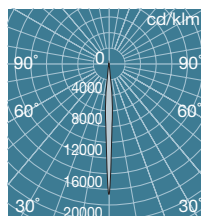
HCF0721BHE + CMT150/WW
13500 lm

Urban Act β Round for 150W metal halide, symmetrical super narrow beam

Model	Colour	Lamp	Lamp holder	Beam angle
HCF1521BHE	Dark Gray	EYE Cera Arc Tubular 150W EYE Color Arc Tubular 150W	E27	6°
HCF1521BHE/W	White	EYE Cera Arc Tubular 150W EYE Color Arc Tubular 150W	E27	6°

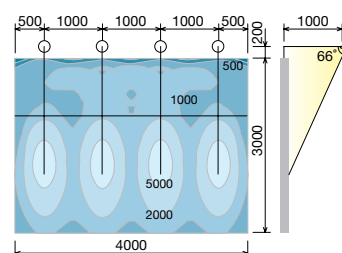
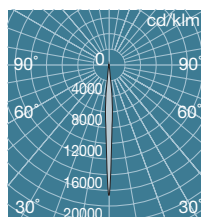
HCF1521BHE + CMT150/WW
13500 lm

Urban Act β Round for 70W metal halide, symmetrical narrow beam

Model	Colour	Lamp	Lamp holder	Beam angle
HCF0722BHE	Dark Gray	EYE Cera Arc Tubular 70W EYE Color Arc Tubular 70W	E27	9°
HCF0722BHE/W	White	EYE Cera Arc Tubular 70W EYE Color Arc Tubular 70W	E27	9°

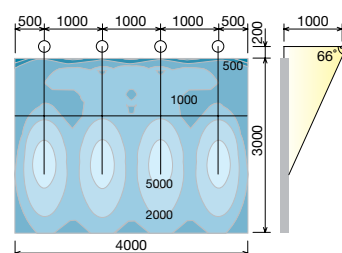
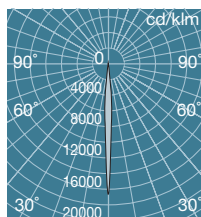
HCF0722BHE + CMT150/WW
13500 lm

Urban Act β Round for 150W metal halide, symmetrical narrow beam

Model	Colour	Lamp	Lamp holder	Beam angle
HCF1522BHE	Dark Gray	EYE Cera Arc Tubular 150W EYE Color Arc Tubular 150W	E27	9°
HCF1522BHE/W	White	EYE Cera Arc Tubular 150W EYE Color Arc Tubular 150W	E27	9°

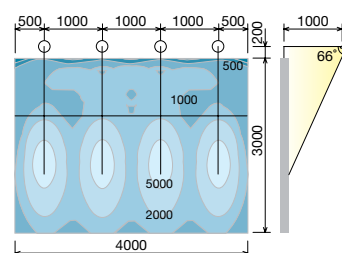
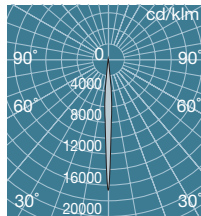
HCF1522BHE + CMT150/WW
13500 lm

Urban Act β Round for 70W metal halide, symmetrical medium wide beam

Model	Colour	Lamp	Lamp holder	Beam angle
HCF0723BHE	Dark Gray	EYE Cera Arc Tubular 70W EYE Color Arc Tubular 70W	E27	23°
HCF0723BHE/W	White	EYE Cera Arc Tubular 70W EYE Color Arc Tubular 70W	E27	23°

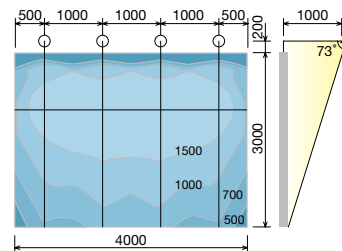
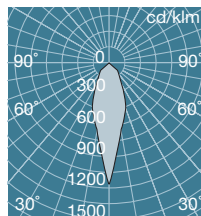
HCF0723BHE + CMT150/WW
13500 lm

Urban Act β Round for 150W metal halide, symmetrical medium wide beam

Model	Colour	Lamp	Lamp holder	Beam angle
HCF1523BHE	Dark Gray	EYE Cera Arc Tubular 150W EYE Color Arc Tubular 150W	E27	23°
HCF1523BHE/W	White	EYE Cera Arc Tubular 150W EYE Color Arc Tubular 150W	E27	23°

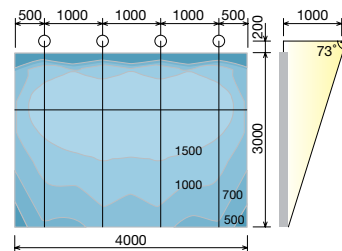
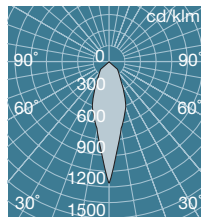
HCF1523BHE + CMT150/WW
13500 lm